

AC INFINITY

CLOUDLINE PRO

MIXED FLOW INLINE FAN SYSTEMS

USER MANUAL

WELCOME

Thank you for choosing AC Infinity. We are committed to product quality and friendly customer service. If you have any questions or suggestions, please don't hesitate to [contact](#) us. Visit www.acinfinity.com and click contact for our contact information.

EMAIL

support@acinfinity.com

WEB

www.acinfinity.com

LOCATION

Los Angeles, CA

PRODUCT

CLOUDLINE PRO S4
CLOUDLINE PRO S6
CLOUDLINE PRO S8
CLOUDLINE PRO S10
CLOUDLINE PRO S12
CLOUDLINE PRO T4
CLOUDLINE PRO T6
CLOUDLINE PRO T8
CLOUDLINE PRO T10
CLOUDLINE PRO T12

MODEL

AI-CLS4
AI-CLS6
AI-CLS8
AI-CLS10
AI-CLS12
AI-CLT4
AI-CLT6
AI-CLT8
AI-CLT10
AI-CLT12

UPC-A

819137020290
819137020306
819137020849
819137020856
819137021006
854759004785
854759004792
819137020276
819137020283
819137021013



EC models CANNOT be daisy chained with DC models. See page 32-34 for more information on daisy-chaining fans and safety precautions.

MANUAL INDEX

Manual Index	Page 5
Product Warning	Page 6
Interference from MH and HPS Lights	Page 7
Key Features	Page 8
Product Contents	Page 9
Installation: Mounting	Page 11
Installation: Hanging	Page 16
Installation: Motor Cap Orientation	Page 20
Installation: Configuration Setup	Page 21
Powering and Setup	Page 22
Controller Mounting	Page 25
UIS™ Platform	Page 30
Compatibility	Page 32
Adding More Fans	Page 33
Adding More Devices	Page 34
Cleaning	Page 35
Programming	Page 37
Other Settings	Page 62
Download the App	Page 63
Add a Device	Page 64
FAQ	Page 71
Other AC Infinity Products	Page 75
Warranty	Page 76

PRODUCT WARNING



TO REDUCE THE RISK OF FIRE, ELECTRIC SHOCK, OR INJURY TO PERSONS, OBSERVE THE FOLLOWING:

1. Ensure your power source conforms to the electrical requirements of this product.
2. Check your local code restrictions for additional safety measures that may be needed for a proper code compliant installation.
3. Read all instructions before installing and using this product.
4. If you are unfamiliar or have doubts about performing this product's installation, seek the services of a qualified, trained, and licensed professional. Inappropriate installation will void this product's warranty.
5. Do not attempt to hardwire this product. Performing any retrofitting actions may result in personal injury and/or electrical damage, and will void this product's warranty.
6. This product must not be used in potentially hazardous locations such as flammable, explosive, chemical-laden, or wet atmospheres.
7. Ducted products must always be vented to outdoor areas.
8. Do not cover power cords with rugs or other fabric materials.
9. This product has rotating parts. Safety precautions should be exercised during the installation, operation, and maintenance of this product.
10. Do not insert or allow fingers or foreign objects to enter any ventilation or exhaust openings as it may cause electric shock, fire, or damage to this product. Do not block or tamper with this product in any manner while it is in operation.
11. Do not depend on the on/off programming as the sole means of shutting power from this product. Unplug the power cord before installing, servicing, or moving this product.
12. Do not operate this product while its cord is damaged, or if it malfunctions, has been dropped, or is damaged in any manner.

INTERFERENCE from MH and HPS LIGHTS

Certain grow light models with HID* ballasts that do not use electromagnetic shielding will create an area of radio frequency interference (RFI). This can distort nearby frequency-sensitive components like internet lines and climate sensors. RFI can be emitted from the ballast's cords or the ballast itself.

Follow these steps to ensure proper functionality and to prevent radio frequency interference from affecting your sensor probe:

TIP 1

Keep the probe cord far away from your ballast's cords to ensure the controller properly detects climate conditions.

You may also wrap the probe cord and create a cone around the sensor head with aluminum foil tape.

TIP 2

Do NOT plug your grow light and inline fan into the same duplex outlet. Plug your grow light and inline fan into separate power strips and electrical sockets.

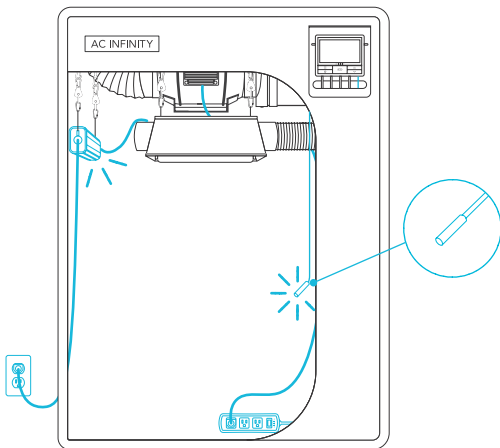

*MH, HPS, CMH, or CHPS

KEY FEATURES

QUIET PWM MOTOR

PWM-controlled motor features precise speed control, reduced rotor noise, and energy-efficient EC voltage.

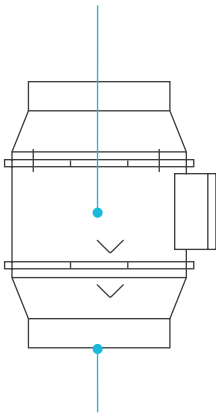

IP-44 PROTECTION

The inline duct fan is sealed to Ingress Protection 44 standards, rated with high resistance to liquids and dust.

STATOR BLADE FANS

Hydro-mechanical stator blades enable efficient airflow delivery in high static pressure environments.

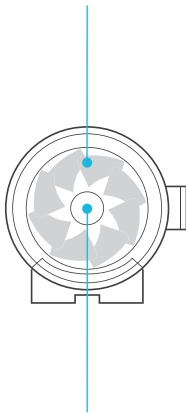

DUAL BALL BEARINGS

The motor contains ball bearings with an estimated 67,000 hour lifespan. Enables the fan to be mounted in any direction.

CONTROLLER 69 PRO

Features automation controls that activate the fan according to temperature, humidity, timer, and schedules.

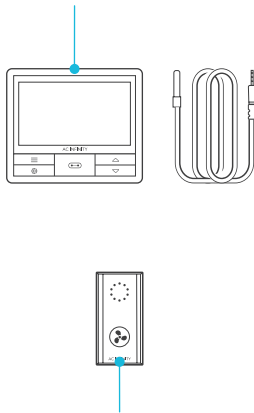

SPEED CONTROLLER

Single button controller with circular readout display that enables fan speed control in ten speeds.

PRODUCT CONTENTS

CLOUDLINE PRO S-Series



SPEED
CONTROLLER
(x1)



UIS F - 4PIN M
ADAPTER
(x1)



WOOD SCREWS
(WALL MOUNT)
(x1)



CONTROLLER
PLATE BOLTS
(x2)

CLOUDLINE PRO T-Series



SMART
CONTROLLER
(x1)



SENSOR
PROBE
(x1)



UIS M - 4PIN F
ADAPTER
(x2)



WOOD SCREWS
(WALL HANG)
(x2)



CONTROLLER
PLATE BOLTS
(x2)

FAN UNIT (Included in both S-Series and T-Series)



DUCT FAN
SYSTEM
(x1)



DUCT
CLAMP
(x2)

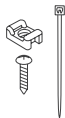

WIRE
MOUNT
(x6)

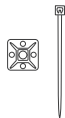

PROBE
MOUNT
(x1)



HOOK AND
LOOP TIES
(x4)



WALL
ANCHOR
(x4)



HANGING
STRAPS
(x2)



DUCT FAN
SCREW SET
(x4)

PRODUCT CONTENTS

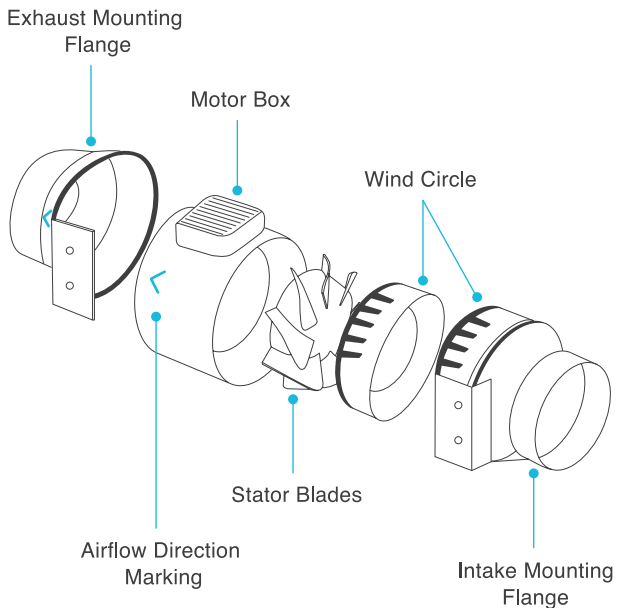

INSTALLATION

MOUNTING

STEP 1

Unscrew and loosen the metal rings using a Phillips screwdriver and pliers.

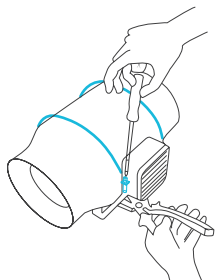

STEP 2

Remove the motor box from the flange bracket.

Remove the wind circle between the motor box and the intake flange.

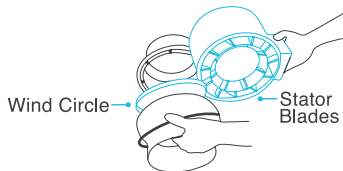
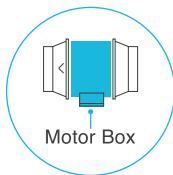

INSTALLATION

MOUNTING

STEP 3

Use the flange bracket to set your desired fan position. Mark the four mounting holes.

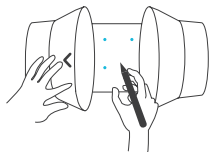

STEP 4

Drill four holes into the marked locations. Make sure your mounting area is structurally sound and free from obstruction.

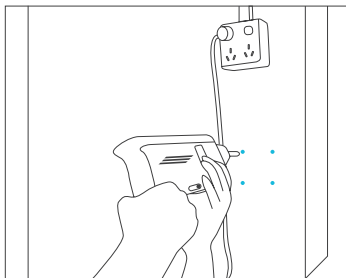

INSTALLATION

MOUNTING

STEP 5

If you are mounting onto anything other than a wood support or stud, insert the included four wall anchors into the drilled mounting holes.

You may need to use a hammer to secure them through the holes.

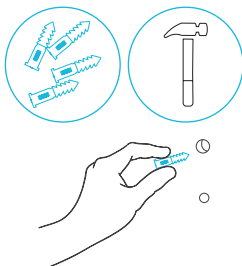

STEP 6

Align the flange bracket's holes with the wall anchors. Screw in four wood screws with a screwdriver or drill to secure the flange bracket.

Make sure its airflow arrow is pointing in your desired direction.

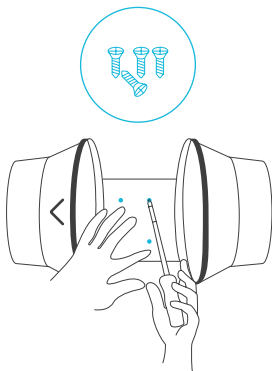

INSTALLATION

MOUNTING

STEP 7

Place the wind circle back into the intake flange and reposition the metal clamps over the flanges if applicable.

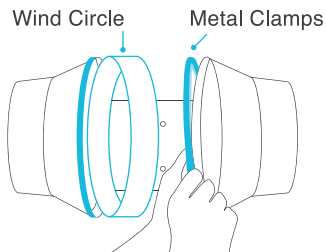

STEP 8

Slide the motor box back into the flange bracket, making sure its airflow arrow is pointing in the same direction as the flange bracket's arrow.

Tighten the metal clamps using a Phillips screwdriver and pliers to secure the motor box.

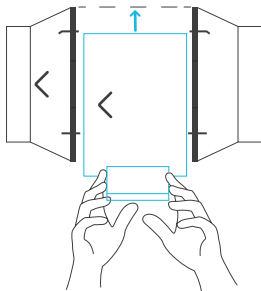

INSTALLATION

MOUNTING

STEP 9

If installing ducting, use the included duct clamps to secure it to either end of the duct fan, making sure there is a tight seal.

Tighten the duct clamps using a flathead screwdriver.

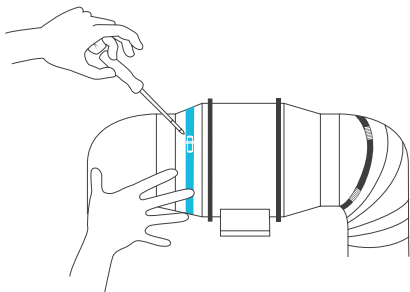

INSTALLATION

HANGING - STRAPS

STEP 1

Loop the strap around the bracket and a pole.

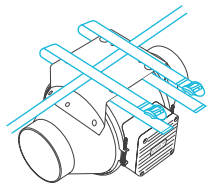

STEP 2

Slip the strap through the inner ladder lock slot from the bottom.



INSTALLATION

HANGING - STRAPS

STEP 3

Route the strap into the outer ladder lock slot from the top. Adjust the length of the completed loop as needed.

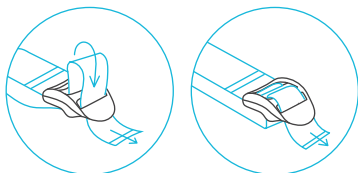

Adjust to size

STEP 4

Tuck the loose end through the center gap of the ladder lock to secure the loop.

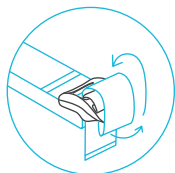

Loop through middle
to lock in place

INSTALLATION

HANGING - STRAPS

STEP 5(a) - Hanging Downward

Let the fan hang by the pole once the straps are secure.

Make sure the fan's airflow arrow is pointing towards your desired direction.

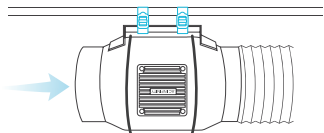

STEP 5(b) - Hanging Upward

To hang the fan right-side up, loop and tighten the straps, as shown in steps 1-4, around the pole.

Hang the fan by the duct flanges to secure it.

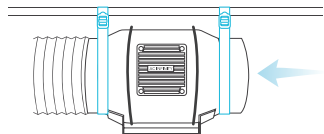

INSTALLATION

HANGING - ROPE CLIPS

HANGING UPWARD

If installing with rope hangers (sold separately), loop the ropes around the flanges and tighten the rope to secure the fan.

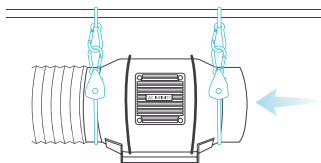

HANGING DOWNWARD

Loop the two rope hangers around a pole and the fan's bracket.

Clip the carabiners onto each other. Shorten the loops as needed.

Make sure the fan's airflow arrow is pointing towards your desired direction.

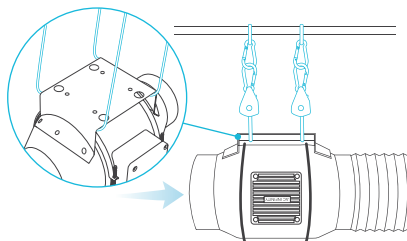

INSTALLATION

MOTOR CAP

STEP 1

Unscrew the motor cap using a screwdriver.

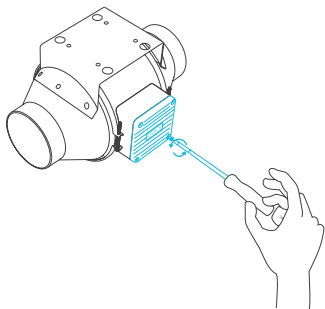

STEP 2

Rotate the motor cap to your desired orientation. Reapply the screws.

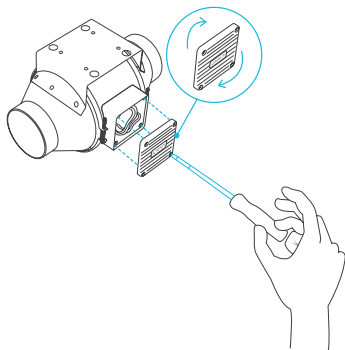

Rotating the motor cap will not void your warranty.

INSTALLATION

CONFIGURATION SETUP

Intake and Exhaust

This fan can be used as either an intake fan or an exhaust fan in grow rooms and larger grow tents. To achieve optimal whole space ventilation, the intake fan or opening - if not using a fan - must be situated at a bottom corner of your grow space. The exhaust fan must be hung (shown below) or mounted at the highest opposite corner possible.

Make sure the intake fan's airflow arrow is pointing towards your grow space and the exhaust fan's arrow pointing away from your grow space.

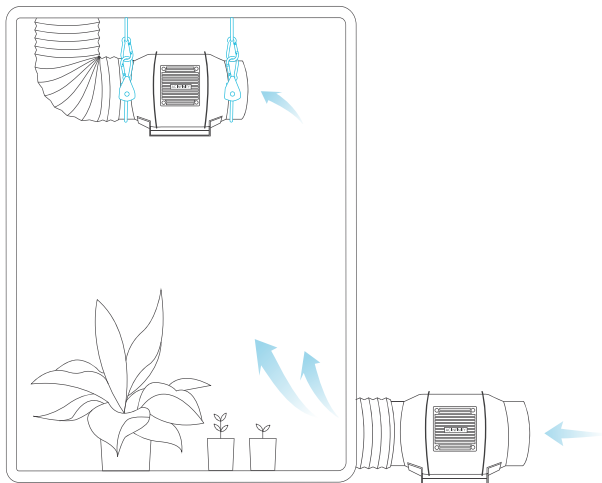

POWERING AND SETUP

S-SERIES

STEP 1

Plug the duct fan's UIS connector into the speed controller's port at the bottom.

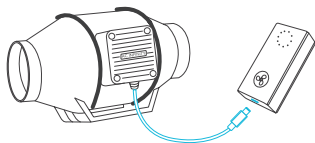

STEP 2

Plug the fan's power cord into a wall outlet. The controller will receive power from the fan to operate. (EC Motor fans only)

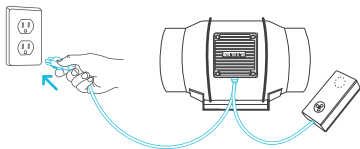

POWERING AND SETUP

T-SERIES

STEP 1

Plug your device's UIS connector into one of the controller's ports.

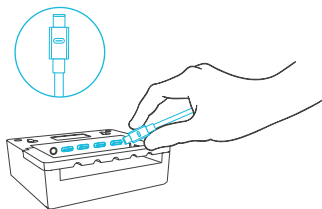

STEP 2

Plug the sensor probe into the controller's 3.5mm jack. Set the probe near your plants in your grow tent for the most accurate reading.

Keep the probe cord away from your HID* grow light ballast's power cord to ensure the controller properly detects climate conditions.

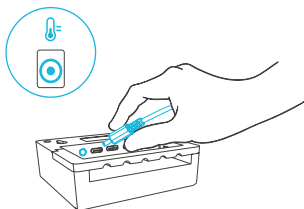

*MH, HPS, CMH, or CHPS

POWERING AND SETUP

T-SERIES

STEP 3

Plug your device's power cord into an AC power outlet to power it and the controller.

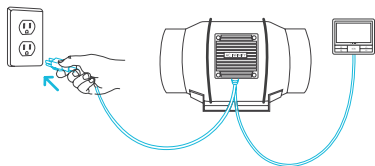

STEP 4

You may use the included tie mounts, wood screws, and wire ties to manage the cords.

Secure the tie mounts onto a surface using the wood screws. Loop the wire ties around the cords into the tie mounts.

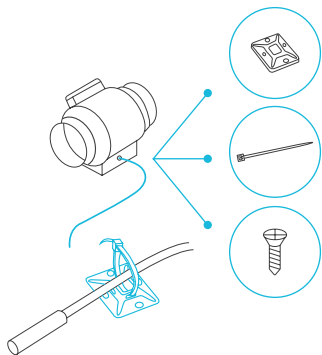

CONTROLLER MOUNTING

S-SERIES

STEP 1 — WALL MOUNTING

Locate a spot free of obstruction and secure the anchor into your wall. Twist the wood screw into the anchors.

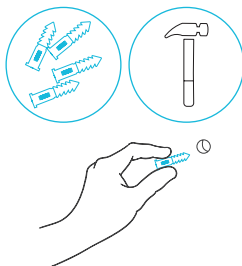

STEP 2 — WALL MOUNTING

Hang the controller by the screw using the hole on the backside.

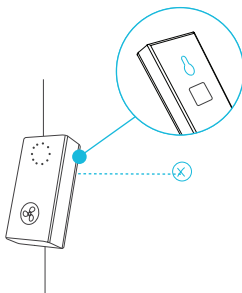

CONTROLLER MOUNTING

S-SERIES

MAGNET MOUNTING

Mount the controller on a steel surface using the magnet located behind the label.

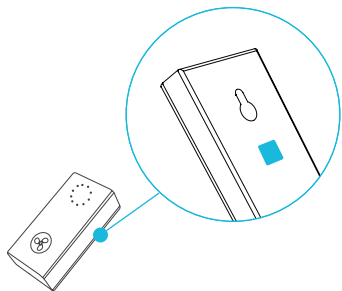
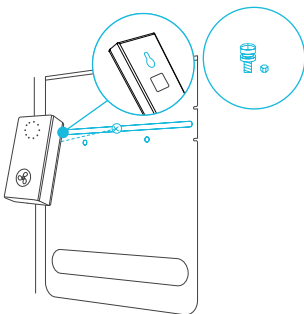

PLATE MOUNTING*

Screw the controller plate bolts into the slot or mounting holes at the upper half of the plate.

Hang the controller by the bolts using the hole on the backside.



*Controller plate not included

CONTROLLER MOUNTING

T-SERIES

STEP 1 — WALL MOUNTING

Locate a spot free of obstruction and secure the anchors into your wall. Twist the wood screws into the anchors.

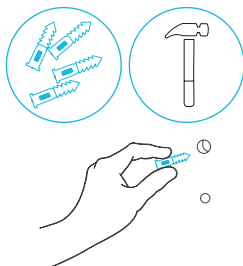

STEP 2 — WALL MOUNTING

Hang the controller by the screws using the holes on the backside.

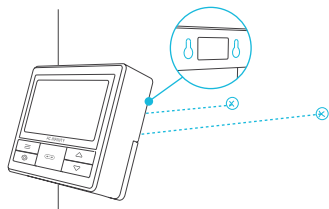

CONTROLLER MOUNTING

T-SERIES

MAGNET MOUNTING

You may also mount the controller onto a steel surface using the magnet located behind the label.

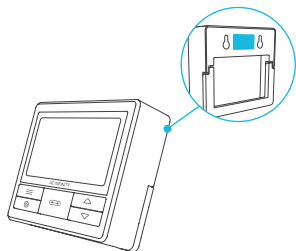
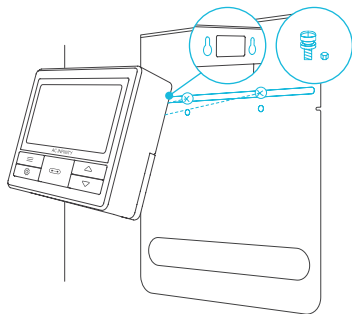

PLATE MOUNTING*

Screw the bolts into the slot or mounting holes at the upper half of the plate.

Hang the controller by the bolts using the holes on the backside.



*Controller plate not included

CONTROLLER MOUNTING

T-SERIES

CORD ARRANGEMENT

Cords may be routed into or outside of the kickstand grooves, and through a cut hole behind the controller.

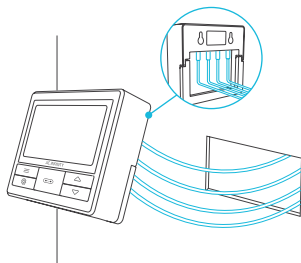

KICKSTANDING

Open the stand behind the controller to set it tilted on your desktop.

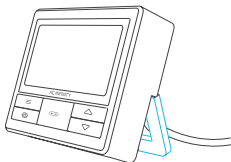

UIS™ PLATFORM

The UIS™ platform enables you to connect a single central controller with several grow devices simultaneously. By creating this fully integrated system, you can power and program all your devices together or separately for optimized grow tent management.

Your grow system can be regulated using your controller hub or remotely on the AC Infinity app (paired with compatible controllers), where you will have access to automation programming and climate data.

You can also connect your favorite grow light and outlet device to integrate them into the UIS platform using our RJ11/12 adapter and control plug module.

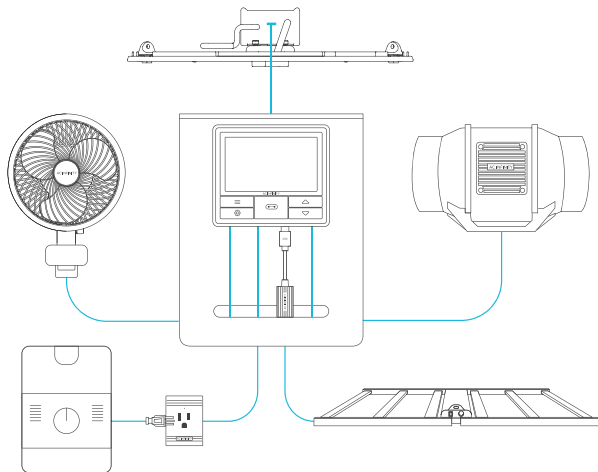

Grow devices will be sold separately and may still be in development at the time of your purchase of this product.

UIS™ PLATFORM

MOLEX ADAPTER

Use the included Molex adapter to plug inline fans with 4-pin Molex connectors into this controller. Plug your fan's Molex connector into the adapter. Then plug the adapter into the controller.

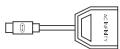

UIS M - 4PIN F
ADAPTER

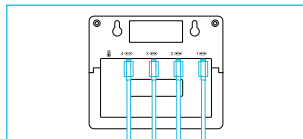

EXTENSION CABLE*

Use male-to-male UIS extension cords to connect devices with female UIS ports at an extended range from your controller.

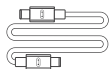

UIS M - M
CORD

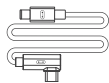

UIS M - M
CLIP FAN CORD

EXPANSION DONGLE*

The expansion dongle will allow you to connect 2 or 4 devices with a single port and can support additional dongles to create more expansion ports (up to 64 units supported with the use of 20 dongles). Intended for exclusive use with AC Infinity controllers built with UIS ports.

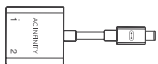

UIS M - M
2 PORT DONGLE

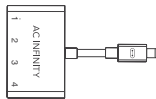

UIS M - M
4 PORT DONGLE

*Not included

COMPATIBILITY

Older generation models that previously used DC motors now contain EC motors in updated builds. Whereas fans that use DC motors connect to its controller to receive power, fans that use EC motors connect to electrical sockets to receive power. Neither the fan nor the controller is backwards compatible with the same product of an older generation that use DC motors and older controllers.

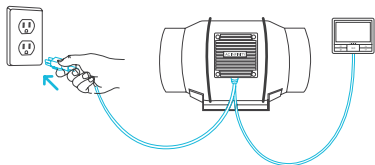

EC Motor - Compatible

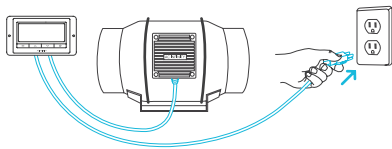

DC - NOT Compatible

ADDING MORE FANS

The CONTROLLER 69 PRO is built with four ports that enable you to power and control multiple fans at the same time. Compatible with inline fans with EC motors only. See image below for a sample configuration.

Multi-Fan Connection

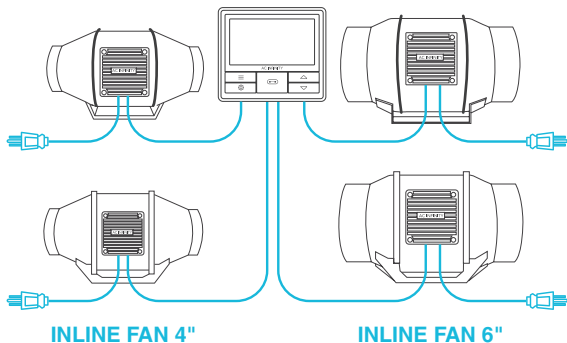

MOLEX ADAPTER

Use the included UIS to 4-pin Molex adapter to connect your fan to the Universal Controller (not included). Plug your fan's UIS connector into the adapter. Then plug the adapter into your controller.

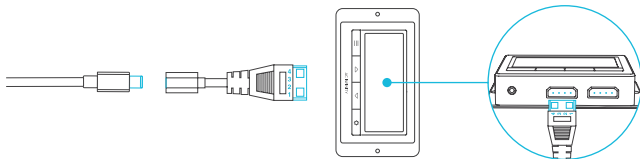

ADDING MORE DEVICES

USING THE DONGLE

Each controller port can support mix-and-matched devices regardless of their size.

When using a 2-port or 4-port dongle, plug your first device into Port 1 for the controller to recognize as the primary device.

All other devices plugged into the dongle will follow programming intended for the device plugged into Port 1.

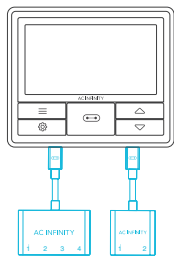

EXTENDING THE CHAIN

When plugging additional dongles into Port 1, all devices plugged into this chain must be of the same type (ex. grow lights of any size) regardless of the length of the dongle chain.

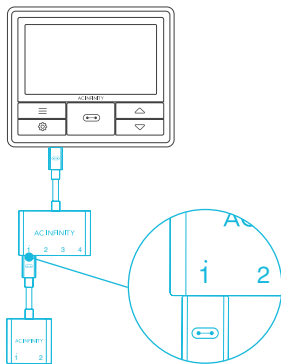

CLEANING

STEP 1

Remove the motor box from the mounting flange. Refer to steps 1-2 on page 11 to learn how to remove the motor box.

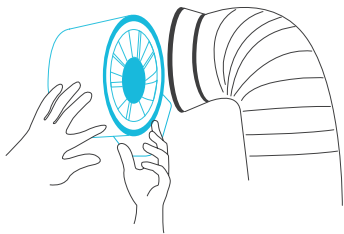

STEP 2

Use a damp cloth to clear the impeller and fan blades of any dust and debris. Remove the wind circle in between the motor box and input flange.



CLEANING

STEP 3

Clear the stator blades of any dust and debris on the opposite end. Clean the area inside the output and exhaust flanges.

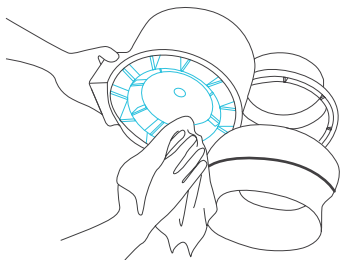

STEP 4

Secure the motor box onto the mounting flanges. Refer to steps 7-9 on page 14-15 to learn how to secure the motor box.

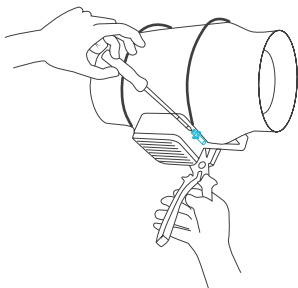

PROGRAMMING

S-SERIES

FAN SPEED ADJUSTING

The controller features a single button that controls the fan speed from 0-10. Pressing the speed button increases the fan speed in one unit increments. Pressing the button at the 10 setting will set the fan speed back to 0.

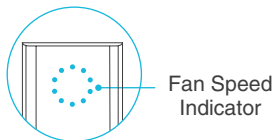
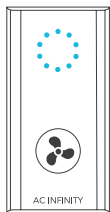

POWERING ON/OFF

Holding the speed button for 4 seconds will turn the fan OFF. Pressing it again from OFF will turn the fan ON at its last speed setting.

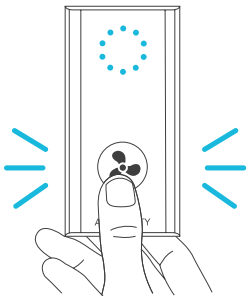

PROGRAMMING

T-SERIES

1. PORT BUTTON

Cycles through up to four connected devices. Each device is programmed independently, or together when navigating to ALL.

4. UP/DOWN BUTTONS

Adjusts the value of your current mode. The up button increases and down button decreases the setting. Hold both to reset values to OFF/Default.

6. PROBE TEMPERATURE

Displays the current temperature that the probe is detecting. Shows "--" if no probe is plugged in. Includes a trend indicator that signals a rise, stability, or fall in temperature within the last hour.

8. PROBE VPD

Displays the current VPD that the probe is detecting (in kPa). Shows "--" if no probe is plugged in. Includes a trend indicator that signals a rise, stability, or fall in VPD within the last hour.

11. CURRENT LEVEL

Displays the connected devices' current setting. Includes a trend indicator that signals if the setting is currently rising, falling, or holding steady.

2. MODE BUTTON

Cycles through the controller's modes: OFF, ON, AUTO (4 triggers), VPD (2 triggers), TIMER TO ON, TIMER TO OFF, CYCLE (ON and OFF), and SCHEDULE (ON and OFF).

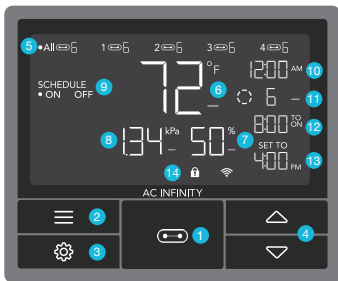

9. CONTROLLER MODE

Displays the controller's current mode. Pressing the mode button cycles through the available modes.

12. COUNTDOWN

Displays the countdown of the TIMER TO ON, TIMER TO OFF, CYCLE, or SCHEDULE mode activates or deactivates the devices. TO ON shows the amount of time left before the devices turn on. TO OFF shows the amount of time left before the device turn off.

3. SETTING BUTTON

Cycles through the controller's settings: DISPLAY, CLOCK, °F / °C, CALIB. T° / H% / kPa, TRANS. T° / H% / kPa, BUFF. T° / H% / kPa, and LEAF OFFSET.

5. PORTS

Displays all connected devices as well as their current level. Digits are displayed by the UIS symbol when a device is plugged into its corresponding port.

7. PROBE HUMIDITY

Displays the current humidity that the probe is measuring. Shows "--" if no probe is plugged in. Includes a trend indicator that signals a rise, stability, or fall in humidity within the last hour.

10. CURRENT TIME

Displays the current time. The internal battery sustains the clock so it does not default to 00:00 if power is cut off.

13. USER SETTING

Displays the value of your current mode. Use the up or down buttons to adjust the value.

14. ALERT ICONS

Displays alerts and statuses of the controller, including the controller lock, CLIMATE alert, and TIMER alert.

PROGRAMMING

T-SERIES

PORTS

Pressing the port button will cycle through the controller's available ports: ALL, 1, 2, 3, and 4. Dot indicates the current device. No digit is displayed if a device is not plugged into the corresponding port.

ALL PORTS

Navigate to the ALL port to set simultaneous programming for all connected devices.

Programming set in this port mode applies to all connected devices, but will not be active if you navigate to other ports. Re-entering the ALL port will resume its programming.

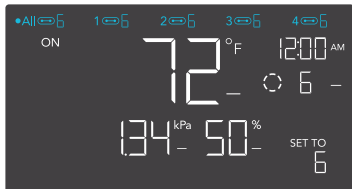

INDIVIDUAL PORT

Navigate to a numbered port with a connected device to set individual programming.

Programming will run in the background even while you navigate to other numbered ports.



PROGRAMMING

T-SERIES

CONTROLLER MODES

Pressing the mode button will cycle through the controller's available programming modes: OFF, ON, AUTO (4 triggers), VPD (2 triggers), TIMER TO ON, TIMER TO OFF, CYCLE (On and Off), and SCHEDULE (On and Off).

OFF MODE

Your devices will not run while in this mode. The OFF Mode setting also serves as the minimum level the other modes will run at while triggered OFF.



MINIMUM LEVEL

Your devices will run at the level set in OFF Mode, as the minimum level, when triggered to turn OFF. These other modes include the AUTO Mode, CYCLE Mode, TIMER TO ON Mode, TIMER TO OFF Mode, and SCHEDULE Mode.

They will run continuously until triggered ON, at which point they will run at the level set in ON Mode.

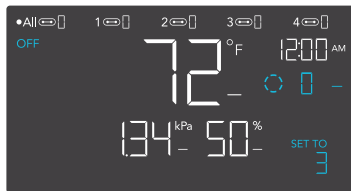

*Example shown

If you want your devices to turn off completely when they're triggered to be OFF, set the OFF Mode level to zero.



PROGRAMMING

T-SERIES

ON MODE

Your devices will actively run at the level set here, regardless of the probe's reading. The ON Mode setting also serves as the maximum level the other modes will run at.

MAXIMUM LEVEL

Your devices will run at the level set in ON Mode, as the maximum level, when triggered ON, as well as in the AUTO Mode, CYCLE Mode, TIMER TO ON Mode, TIMER TO OFF Mode, and SCHEDULE Mode.

Do not set the ON Mode figure to zero or your device will turn off when it's triggered ON in all modes.



*Example shown



PROGRAMMING

T-SERIES

AUTO MODE (HIGH TEMPERATURE TRIGGER)

Pressing the up or down button sets the high temperature trigger. The devices will activate if the probe's reading meets or exceeds this threshold.

Once triggered, the devices will gradually ramp up to the level set in ON mode. If the probe's reading falls below this trigger point, the devices will gradually slow down to a stop or at the level set in OFF mode.

You may set this trigger below the low temperature trigger to create a specific range in which the devices are active.

This is typically used with devices like air conditioners and cooling fans to help lower the temperature when it gets too hot. For example, if you set a high temperature trigger of 90°F, then your device will activate when the temperature reaches 90°F or higher, and turn off when it falls below 90°F. Products shown here may still be in development.

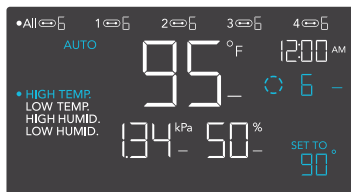

Any of the four trigger points can activate while you are in AUTO Mode, even if you are viewing another trigger point. Set a trigger point to OFF if not in use, by holding down the up and down button. If there is a level set in OFF Mode other than zero the devices will run at that level when triggered to turn off.

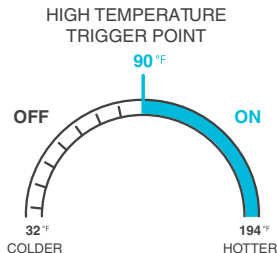
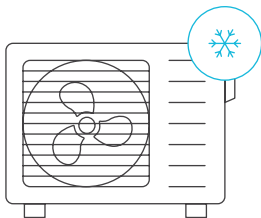

PROGRAMMING

T-SERIES

AUTO MODE (LOW TEMPERATURE TRIGGER)

Pressing the up or down button sets the low temperature trigger. The devices will activate if the probe's reading meets or falls below this threshold.

Once triggered, the devices will gradually ramp up to the level set in ON mode. If the probe's reading rises above this trigger point, the devices will gradually slow down to a stop or at the level set in OFF mode.

You may set this trigger above the high temperature trigger to create a specific range in which the devices are active.

This is typically used with devices like heaters and seedling mats to help raise the temperature when it gets too cold. For example, if you set a low temperature trigger of 40°F, then your device will activate when the temperature falls to 40°F or lower, and turn off when it rises above 40°F. Products shown here may still be in development.

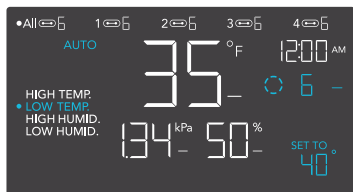

Any of the four trigger points can activate while you are in AUTO Mode, even if you are viewing another trigger point. Set a trigger point to OFF if not in use, by holding down the up and down button. If there is a level set in OFF Mode other than zero the devices will run at that level when triggered to turn off.

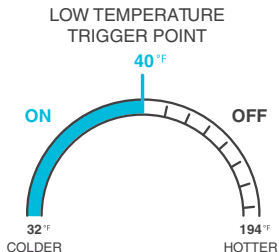
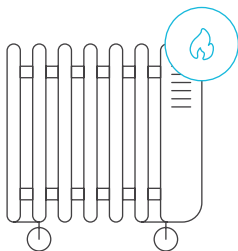

PROGRAMMING

T-SERIES

AUTO MODE (HIGH HUMIDITY TRIGGER)

Pressing the up or down button sets the high humidity trigger. The devices will activate if the probe's reading meets or exceeds this threshold.

Once triggered, the devices will gradually ramp up to the level set in ON mode. If the probe's reading falls below this trigger point, the devices will gradually slow down to a stop or at the level set in OFF mode.

You may set this trigger below the low humidity trigger to create a specific range in which the devices are active.

This is typically used with devices like dehumidifiers to help lower the humidity when it gets too humid. For example, if you set a high humidity trigger of 70%, then your device will activate when the humidity rises to 70% or higher, and turn off when it falls below 70%. Products shown here may still be in development.

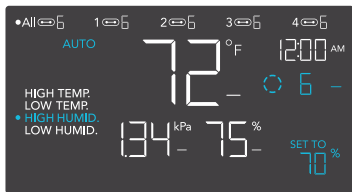

Any of the four trigger points can activate while you are in AUTO Mode, even if you are viewing another trigger point. Set a trigger point to OFF if not in use, by holding down the up and down button. If there is a level set in OFF Mode other than zero the devices will run at that level when triggered to turn off.

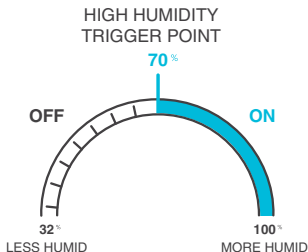
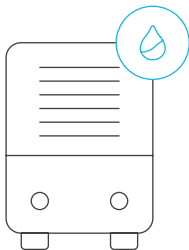

PROGRAMMING

T-SERIES

AUTO MODE (LOW HUMIDITY TRIGGER)

Pressing the up or down button sets the low humidity trigger. The devices will activate if the probe's reading meets or falls below this threshold.

Once triggered, the devices will gradually ramp up to the level set in ON mode. If the probe's reading rises above this trigger point, the devices will gradually slow down to a stop or at the level set in OFF Mode.

You may set this trigger above the high humidity trigger to create a range in which the devices are active.

This is typically used with devices like humidifiers to help raise the humidity when it gets too dry. For example, if you set a low humidity trigger of 50%, then your device will activate when the humidity falls to 50% or lower, and turn off when it rises above 50%. Products shown here may still be in development.

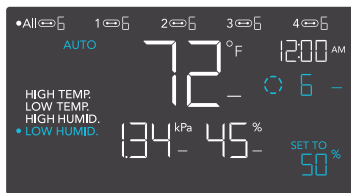

Any of the four trigger points can activate while you are in AUTO Mode, even if you are viewing another trigger point. Set a trigger point to OFF if not in use, by holding down the up and down button. If there is a level set in OFF Mode other than zero the devices will run at that level when triggered to turn off.

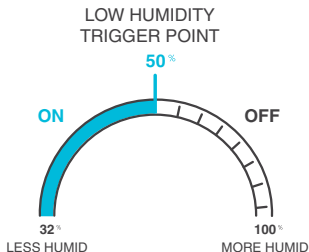
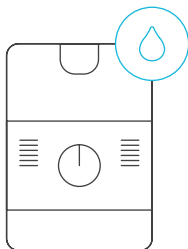

PROGRAMMING

T-SERIES

VPD MODE (HIGH VPD TRIGGER)

Pressing the up or down button sets the high VPD trigger. The devices will activate if the probe's reading meets or exceeds this threshold.

Once triggered, the devices will gradually ramp up to the level set in ON mode. If the probe's reading falls below this trigger point, the devices will gradually slow down to a stop or at the level set in OFF mode.

You may set this trigger below the low VPD trigger to create a specific range in which the devices are active.



Either of the two trigger points can activate while you are in VPD Mode, even if you are viewing another trigger point. Set a trigger point to OFF if not in use, by holding down the up and down button. If there is a level set in OFF Mode other than zero the devices will run at that level when triggered to turn off.

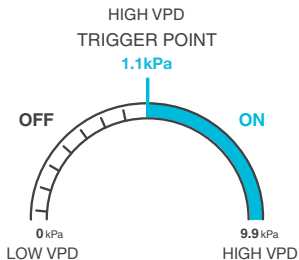

PROGRAMMING

T-SERIES

VPD MODE (LOW VPD TRIGGER)

Pressing the up or down button sets the low VPD trigger. The devices will activate if the probe's reading meets or falls below this threshold.

Once triggered, the devices will gradually ramp up to the level set in ON mode. If the probe's reading falls below this trigger point, the devices will gradually slow down to a stop or at the level set in OFF mode.

You may set this trigger below the low VPD trigger to create a specific range in which the devices are active.



Either of the two trigger points can activate while you are in VPD Mode, even if you are viewing another trigger point. Set a trigger point to OFF if not in use, by holding down the up and down button. If there is a level set in OFF Mode other than zero the devices will run at that level when triggered to turn off.

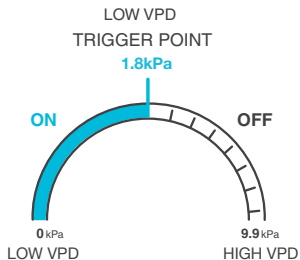

PROGRAMMING

T-SERIES

TIMER TO ON MODE

Pressing the up or down button sets a countdown time. During the countdown, your device will be set to OFF. Once the timer ends, your device will trigger to turn on. If there is a level set in OFF Mode, the devices will run at that level during the countdown and when triggered to turn off.

The countdown will begin if no buttons are pressed for 5 seconds. The time left on the countdown is shown on the lower right corner of the display above the setting. Leaving the timer mode while the countdown is running will pause it until you return to this mode.

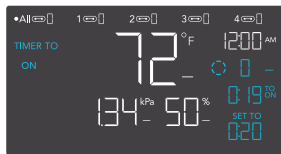

TIMER TO ON
(COUNTDOWN END POINT)

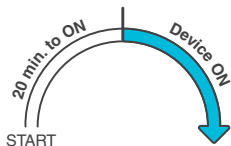

TIMER TO OFF MODE

Pressing the up or down button sets a countdown time. During the countdown, your device will be set to ON. Once the timer ends, your device will trigger to turn off. If there is a level set in OFF Mode, the devices will run at that level after the end of the countdown.

The countdown will begin if no buttons are pressed for 5 seconds. The time left on the countdown is shown on the lower right corner of the display above the setting. Leaving the timer mode while the countdown is running will pause it until you return to this mode.



TIMER TO OFF
(COUNTDOWN END POINT)

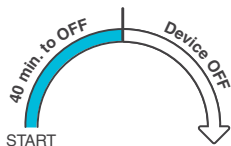

PROGRAMMING

T-SERIES

CYCLE MODE (ON AND OFF)

Set an on duration and an off duration for the devices to cycle through continuously. Press the up or down button to first set a duration for the devices to activate. Then press the mode button again and set a duration for the devices to deactivate.

When the devices are activated, they will run at the level set in ON Mode. When the devices are deactivated, they will run at the level set in OFF Mode.

The countdown will begin if no buttons are pressed for 5 seconds. The time left on the countdown before the next ON or OFF phase is displayed below the current level. Leaving the cycle mode while the countdown is running will pause it until you return to this mode.

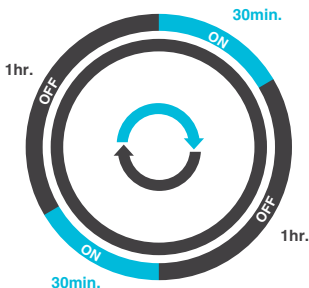

If there is a level set in OFF Mode other than zero, the devices will run at that level when triggered to turn off.

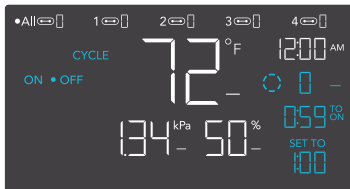
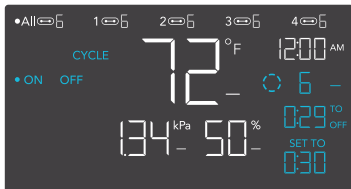

PROGRAMMING

T-SERIES

SCHEDULE MODE (ON AND OFF)

Sets an on clock-time and an off clock-time schedule for the devices to follow daily. Press the up or down button to first set up an on clock-time to trigger ON mode, then press the mode button to set an off clock-time to trigger OFF mode. Please be sure to set the current clock time under settings.

When the devices are triggered to activate, they will run at the level set in ON Mode. When the devices are triggered to deactivate, they will run at the level set in OFF Mode.

The countdown will begin if no buttons are pressed for 5 seconds. The time left on the countdown before the next on or off phase is displayed below the current level. The devices will not follow this schedule if you leave this mode. If you re-enter the Schedule Mode, they will continue to follow the latest schedule you have set.

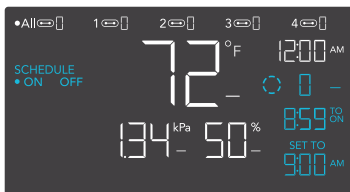

If there is a level set in OFF Mode other than zero, the devices will run at that level when triggered to turn off.

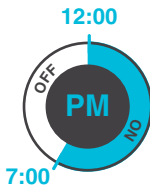
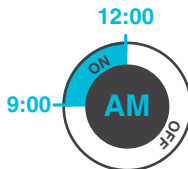

PROGRAMMING

T-SERIES

CONTROLLER SETTINGS

Pressing the setting button will cycle through the controller's available settings: DISPLAY, CLOCK, °F / °C, CALIB. T° / H% / kPa, TRANS. T° / H% / kPa, BUFF. T° / H% / kPa, and LEAF OFFSET.

DISPLAY SETTING

Adjusts the display brightness and auto-dimming. Press the up or down button to cycle through levels 1, 2, 3, A2 and A3; 3 being the highest brightness setting, while 1 is the lowest. In settings 1, 2 and 3, the display will stay at that brightness level and will not automatically dim the display.

A2 and A3 will set the brightness level at 2 and 3, respectively, and will dim down the brightness level 1 when the controller is not being used after 15 seconds.



TOGGLING THE DISPLAY

Lock the controller by holding the setting button.

Press the setting button to turn the display off. Pressing the setting button again will turn the display back on.

Programs will still run in the background while the LCD screen is off.



PROGRAMMING

T-SERIES

°F/°C SETTING

Changes the displayed units to Fahrenheit or Celsius. Press the up or down button to cycle through F and C. All displayed units will automatically convert when adjusting this setting.

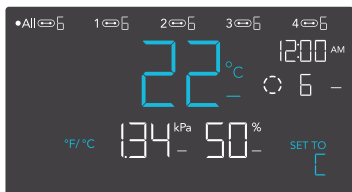

CLOCK SETTING

Adjusts the current clock time. Press the up or down button to increase or decrease the time. Once you cycle through 12:00 each time, the units will automatically change to AM or PM. The clock time is located at the top right corner of the display.



PROGRAMMING

T-SERIES

CALIBRATION TEMPERATURE SETTING

Adjusts the temperature reading the sensor probe is measuring. Press the up or down button to increase or decrease the data figure in 1° increments. The calibration cycle ranges from -20°F to 20°F (or -10°C to 10°C) and will be applied to the sensor probe's measurements.

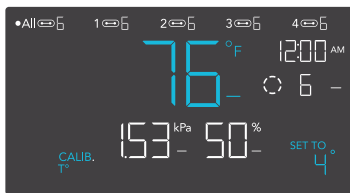

CALIBRATION HUMIDITY SETTING

Adjusts the relative humidity reading the sensor probe is measuring. Press the up or down button to increase or decrease the data figure in 1% increments. The calibration cycle ranges from -10% to 10% and will be applied to the sensor probe's measurements.

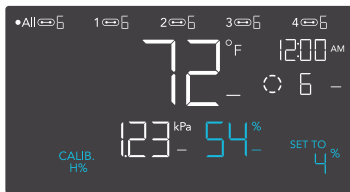

CALIBRATION LEAF OFFSET SETTING

Adjusts the VPD reading the sensor probe is measuring. Press the up or down button to increase or decrease the data figure in 1° increments. The calibration cycle ranges from -20°F to 20°F (or -10°C to 10°C) and will be applied to the sensor probe's measurements.

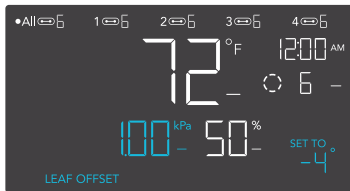

PROGRAMMING

T-SERIES

TRANSITION TEMPERATURE SETTING

Adjusts how gradually your device will shift between levels when triggered ON by the AUTO Mode's temperature trigger. This will determine how much the probe temperature needs to increase to step up to the next level setting.

The higher the transition setting is, the wider the temperature gap is between levels. The lower the transition setting is, the smaller the temperature gap is between levels. If this figure is set to zero, your device will jump to your maximum level when triggered ON.

Press the up or down button to set a transition threshold between 0°F and 20°F (0°C and 10°C). When the sensor temperature first reaches or crosses the temperature trigger point, the level will increase by one (exiting OFF Mode). Each time the threshold level is crossed, the level will ramp up by one until it reaches the level set in ON Mode.

EXAMPLE

In this example, your high temperature trigger is set at 80°F, the OFF Mode level is 0, and the ON Mode level is 6. If the transition threshold is set to 0°F, then once the sensor temperature reaches or exceeds 80°F, the devices will trigger to run at level 1. However, if the transition threshold is set to 2°F, then the devices will trigger to run at level 1 when the temperature reaches or exceeds 80°F. It will then ramp up to level 2 when the temperature reaches or exceeds 82°F, level 3 at 84°F, etc. From 90°F on, it will run at level 6, the level set in ON Mode.

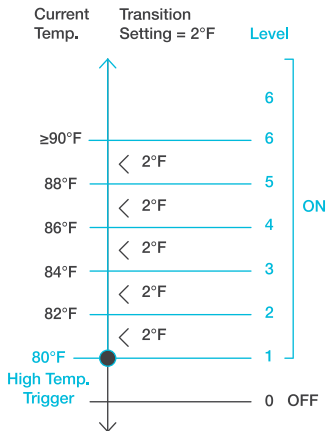
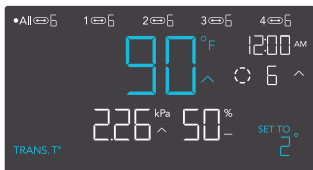

PROGRAMMING

T-SERIES

TRANSITION HUMIDITY SETTING

Adjusts how gradually your device will shift between levels when triggered ON by the AUTO Mode's humidity trigger. This will determine how much the probe humidity needs to increase to step up to the next level setting.

The higher the transition setting is, the wider the humidity gap is between levels. The lower the transition setting is, the smaller the humidity gap is between levels. If this figure is set to zero, your device will jump to your maximum level when triggered ON.

Press the up or down button to set a transition threshold between 0% and 10%. When the sensor humidity first reaches or crosses the humidity trigger point, the level will increase by one (exiting OFF Mode). Each time the threshold level is crossed, the level will ramp up by one until it reaches the level set in ON Mode.

EXAMPLE

In this example, your high humidity trigger is set at 70%, the OFF Mode level is 0, and the ON Mode level is 6. If the transition threshold is set to 0%, once the sensor humidity reaches or exceeds 70% then the devices will trigger to run at level 7. However, if the transition threshold is set to 2%, then the devices will trigger to run at level 1 when it reaches or exceeds 70%. It will then step up to level 2 when reaching or exceeding 72%, level 3 at 74%, etc. From 80% on, it will run at level 6, the level set in ON Mode.

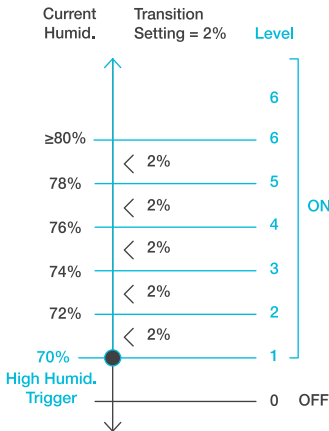
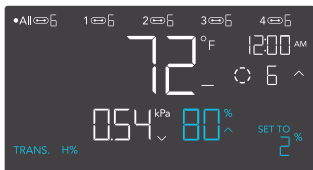

PROGRAMMING

T-SERIES

TRANSITION VPD SETTING

Adjusts how gradually your device will shift between levels when triggered ON by the VPD trigger. This will determine how much the probe VPD needs to increase to step up to the next level setting.

The higher the transition setting is, the wider the VPD gap is between levels. The lower the transition setting is, the smaller the VPD gap is between levels. If this figure is set to zero, your device will jump to your maximum level when triggered ON.

Press the up or down button to set a transition threshold between 0.1 kPa and 1.0 kPa. When the sensor VPD first reaches or crosses the VPD trigger point, the level will increase by one (exiting OFF Mode). Each time the threshold level is crossed, the level will ramp up by one until it reaches the level set in ON Mode.

EXAMPLE

In this example, your high VPD trigger is set at 0.1 kPa, the OFF Mode level is 0, and the ON Mode level is 6. If the transition threshold is set to 0 kPa, then once the sensor temperature reaches or exceeds 0.1 kPa, the devices will trigger to run at level 6. However, if the transition threshold is set to 0.2 kPa, then the devices will trigger to run at level 1 when the VPD reaches or exceeds 0.1 kPa. It will then ramp up to level 2 when the VPD reaches or crosses 0.3 kPa, level 3 at 0.5 kPa, etc. From 1.1 kPa on, it will run at level 6, the level set in ON Mode.

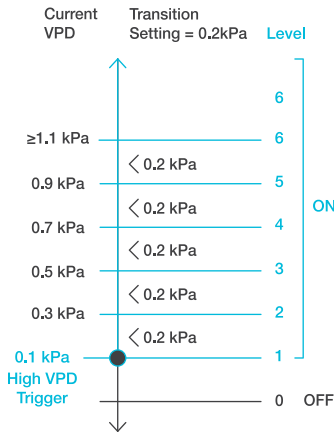

PROGRAMMING

T-SERIES

BUFFER TEMPERATURE SETTING

The buffer figure will create a trigger-off point below your set trigger point to prevent your device from shutting off too quickly. Press the up or down button to cycle through buffer range from 0°F to 8°F (or 0°C to 4°C).

In high temperature triggers, your device will turn on, only turning off when the temperature falls below your buffer setting.

In low temperature triggers, your device will turn on, only turning off when the temperature rises above your set buffer setting.

EXAMPLE

In this example, your High Temperature Trigger is set at 89°F and your Temperature Buffer is set at 6°F. Your device will trigger on when it meets or rises above 89°F, and only trigger off when it falls below 83°F. The 83°F figure is obtained by taking your High Temperature Trigger of 89°F and subtracting your Temperature Buffer of 6°F.

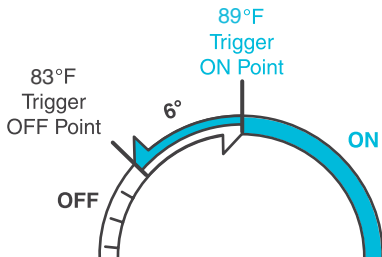
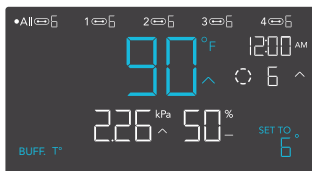

PROGRAMMING

T-SERIES

BUFFER HUMIDITY SETTING

The buffer figure will create a trigger-off point below your set trigger point to prevent your device from shutting off too quickly. Press the up or down button to cycle through buffer range from 0% to 10%.

In high humidity triggers, your device will turn on, only turning off when the humidity falls below your buffer setting.

In low humidity triggers, your device will turn on, only turning off when the humidity rises above your set buffer setting.

EXAMPLE

In this example, your High Humidity Trigger is set at 49% and your Humidity Buffer is set at 4%. Your device will trigger on when it meets or rises above 49%, and only trigger off when it falls below 45%. The 45% figure is obtained by taking your High Humidity Trigger of 49% and subtracting your Humidity Buffer of 4%.

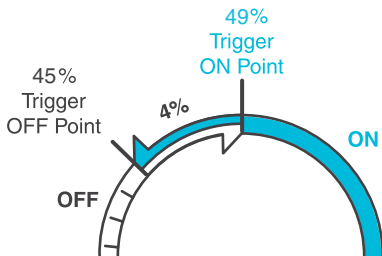
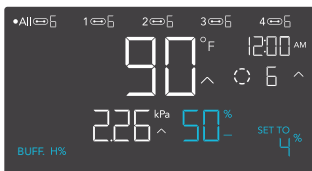

PROGRAMMING

T-SERIES

BUFFER VPD SETTING

The buffer figure will create a trigger-off point below your set trigger point to prevent your device from shutting off too quickly. Press the up or down button to cycle through buffer range from 0.1 kPa and 1.0 kPa.

In high VPD triggers, your device will turn on, only turning off when the VPD falls below your buffer setting.

In low VPD triggers, your device will turn on, only turning off when the VPD rises above your set buffer setting.

EXAMPLE

In this example, your High VPD Trigger is set at 2.51 kPa and your VPD Buffer is set at 0.2 kPa. Your device will trigger on when it meets or rises above 2.51 kPa, and only trigger off when it falls below 2.31 kPa. The 2.51 kPa figure is obtained by taking your High VPD Trigger of 2.51% and subtracting your VPD Buffer of 0.2 kPa.

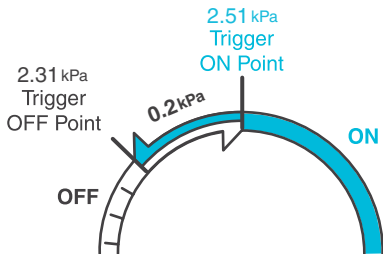
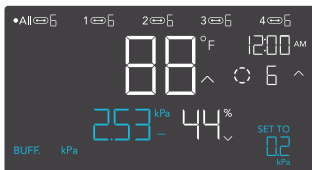

PROGRAMMING

T-SERIES

ALERT ICONS

The alert icons are displayed at the top of the screen. Icons may flash when the controller signals an alert to notify you of any triggered function or alarm.



ADVANCE PROGRAMMING

Displays when an advance program set in the app is active. "ADV." will appear and override the controller if an automation program is in use.



AUTO MODE ALERT

Flashes whenever any of the auto mode triggers (high temperature, low temperature, high humidity, or low humidity) activate your devices.



TIMER ALERT

Flashes when a countdown has completed for TIMER TO ON, TIMER TO OFF, CYCLE, or SCHEDULE Mode.



VPD ALERT

Flashes whenever either VPD mode triggers (high VPD or low VPD) activate your devices.

PROGRAMMING

T-SERIES

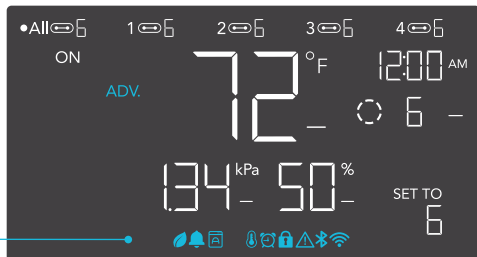

WI-FI

Appears when the physical controller is connected to the app via Wi-Fi.



DISPLAY LOCK ALERT

Displays when you lock the controller. The icon will flash and beep if you attempt to adjust the controller while it is still locked.



ALERT

Flashes and beeps with an alert whenever a plugged-in device experiences interference to its functioning. Check your devices for possible issues.



ALARM

Flashes and beeps with an alert if the temperature/humidity/VPD meet the trigger point set in the app.

OTHER SETTINGS

FACTORY RESET

Holding the mode, up, and down buttons together for 5 seconds will reset your controller and restore factory settings. This clears all user parameters in each controller mode and setting.

HOLD +   

CONTROLLER LOCK

Holding the setting button will lock the controller in your current mode. While your controller is locked, no parameters may be adjusted, nor will you be able to switch modes. Holding the setting button again will unlock the controller.

HOLD + 

HIDE SCREEN

Lock the controller so no settings can be adjusted. See above. Then press the setting button to turn the display off. Pressing it again will turn the display back on. Programs will still run in the background while the LCD screen is off.

PRESS + 

JUMP TO OFF MODE

Holding the mode button for 3 seconds while in any mode or setting will automatically jump to OFF Mode. This function is disabled if the controller is locked.

HOLD + 

RESET TO OFF/DEFAULT

Holding the up and down buttons together for 2 seconds will reset the value of your current mode or controller setting to OFF/Default. Pressing either the up or down button will return to the previous value.

HOLD +  

AUTO INCREASING OR DECREASING

Holding the up or down button will increase or decrease the user setting automatically until you release them.

HOLD + 

HOLD + 

DOWNLOAD THE APP

THE AC INFINITY APP

The AC Infinity app enables you to connect with the next generation of our intelligent controllers, giving you access to advance programs and environmental data*.

1

Download the AC Infinity app from the App Store or Play Store by searching “AC Infinity”.



2

Open the AC Infinity app and follow the instructions on page 64-70 to pair your controller with the app.



HOW TO USE THE APP

Visit our website at www.acinfinity.com or open your smartphone camera and scan the QR code below for more information on the AC Infinity app.



*Appearance and features subject to change.

ADD A DEVICE

BLUETOOTH

SETUP AND PAIRING

Power your device on before pairing your controller with the app. Logging in or creating an account beforehand will expedite the pairing process. Have your Wi-Fi network's name and password ready.

1

Tap on the "+" tab to add your smart device.

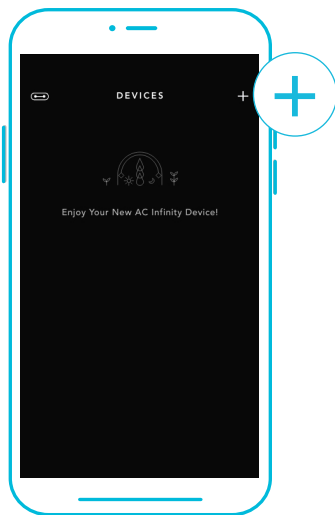

2

Select "Smart Controllers".

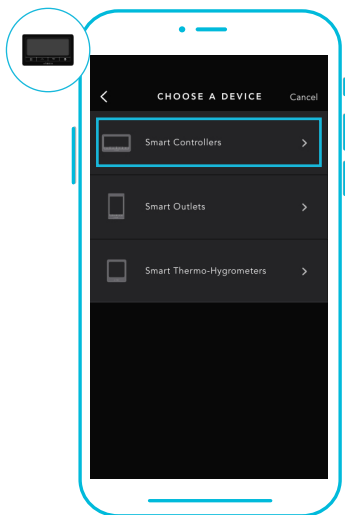

Wi-Fi and location permissions must be enabled on your mobile device before starting the pairing process.

ADD A DEVICE

BLUETOOTH

3

Select CONTROLLER 69 PRO.

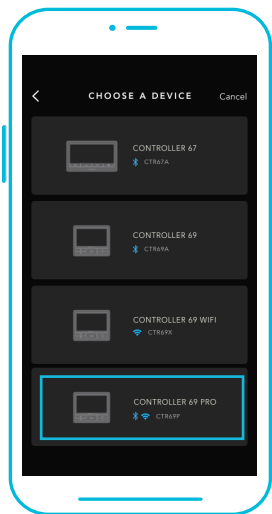

4

Hold the port button for 5 seconds to activate Bluetooth. Wait for the Bluetooth icon to start flashing on your controller's screen to release the button.



ADD A DEVICE

BLUETOOTH

5

Connect using Bluetooth. To connect using Wi-Fi, skip to step 8.

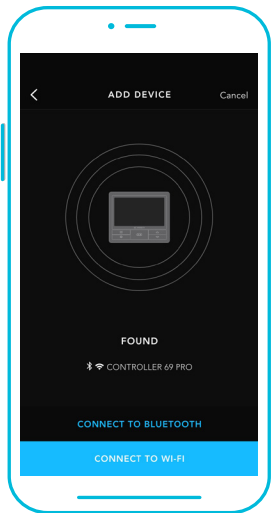

6

Connecting with Bluetooth will disable Wi-Fi functionality. Go to the app settings page to re-enable and connect using Wi-Fi.

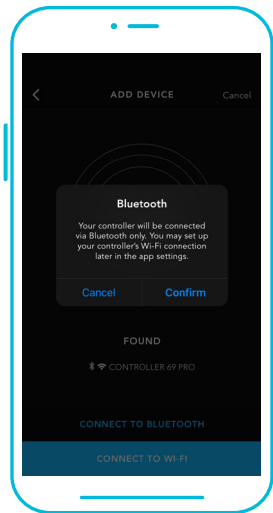

When pairing the app around multiple controllers, move your mobile device closer to your desired controller.

ADD A DEVICE

BLUETOOTH

7

Tap the DONE button to complete the pairing process.

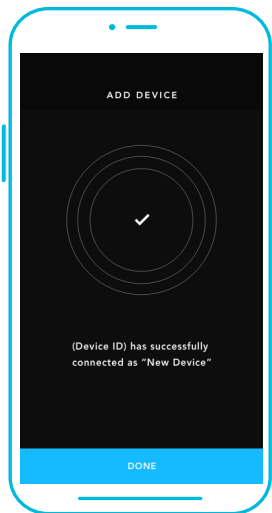

ADD A DEVICE

WI-FI

8

Repeat steps 1-5. Log in or create an account to continue.

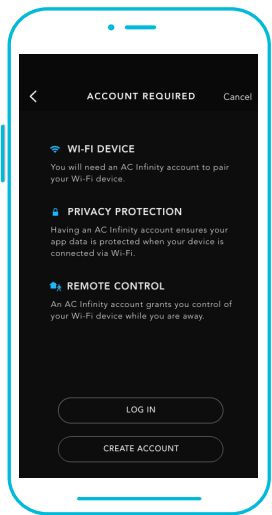

9

Enter your Wi-Fi network's password. You may also connect to an alternate 2.4 GHz router*.

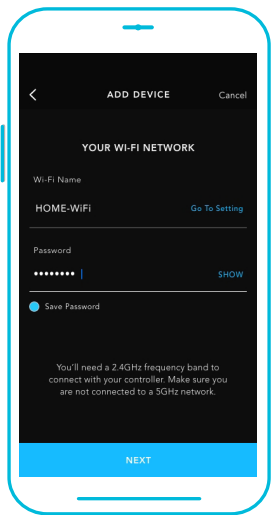

When pairing the app around multiple controllers, move your mobile device closer to your desired controller.

ADD A DEVICE

WI-FI

10

Follow these tips if the pairing process is unsuccessful.

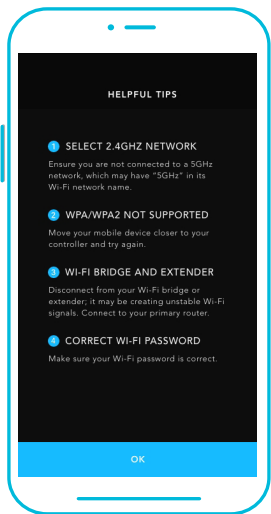

11

Tap the DONE button to complete the pairing process.

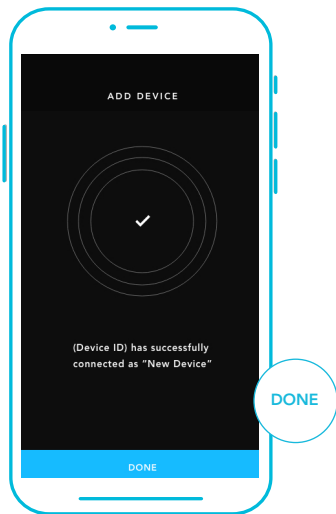

*This controller is only compatible with 2.4 GHz frequency band routers. When connecting using Wi-Fi, make sure your mobile device is not connected to a 5 GHz frequency band network.

ADD A DEVICE

WI-FI

12

Your controller will appear in your smart device with a unique ID.

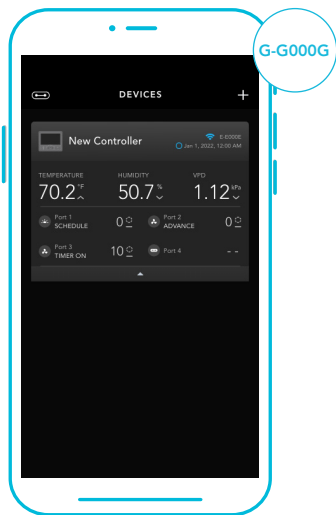

CONTROLLER 69 PRO FAQ

Q: What devices are compatible with the CONTROLLER 69 PRO?

A: All AC Infinity devices that contain a UIS connector are compatible. If your AC Infinity device has a 4-pin Molex connector and an EC motor, it may still be compatible with the use of a UIS adapter to convert its connector to fit with the controller.

Q: What does “level” refer to in the controller and app?

A: The level represents the intensity the device is running at. This is represented by a digit 0 to 10. Zero means the device is off, and 10 represents its running at its maximum. For fan devices, the level would be referring to their speed. For light devices, the level would be referring to its brightness. Note that on and off devices do not have a level setting.

Q: Why is my device is not turning off when the programming is triggering it to be off?

A: The figure set in OFF Mode determines the device’s level when it’s triggered to be OFF in all other modes. Set this figure to zero if you want the device to turn off when triggered OFF.

If this is occurring in AUTO Mode, check the points of your high and low triggers, which can all activate concurrently. Turn off any triggers that are not in use. If you are using the app, check to see if any ADVANCE programming is active, which can override any control programming.

Q: Why does my device not run or run at low levels when the programming is triggering it to be on?

A: The figure set in ON Mode determines the device’s level when it’s triggered to be ON in all other modes. Make sure this figure is not set to zero or the device will not run when triggered to be ON.

If this is occurring in AUTO Mode, check the points of your high and low triggers, which can all activate concurrently. Turn off any triggers that are not in use. If you are using the app, check to see if any ADVANCE programming is active, which can override any control programming.

CONTROLLER 69 PRO FAQ

Q: How do I stop my device from turning on and off too quickly in AUTO Mode?

A: The figure set in the TRANSITION under SETTINGS will determine how the device ramps up in levels when triggered to run in AUTO Mode. Set a transition threshold X. For every multiple of X that has surpassed your trigger point, the device will increase by one level. The lower the transition threshold is set to, the easier it will be for the device to ramp up in levels. If set to zero, the device will jump to the max set speed without ramping when triggered. This may cause the device to turn on and off quickly if the climate fluctuates back and forth. Increase the transition threshold number to help smooth out the transitions. Check the points of your high and low triggers, which can all activate concurrently. Turn off any triggers that are not in use.

Q: How do I set a minimum speed for constant ventilation, that would ramp up when triggered?

A: If a fan device is connected, the figure set in OFF Mode determines the fan speed when it's triggered to be OFF in all other modes. When the fan isn't triggered ON, it will be considered OFF and so it will run at that minimum speed continuously. Once triggered ON, it will change its speed to the figure set under ON Mode.

Q: Where is the best place to position the sensor probe?

A: Place the sensor probe as close as possible to the hottest or most humid spot in your space.

Q: Do I need to remove the plastic cap from the probe?

A: Yes. You will need to remove the plastic cap so the probe can accurately read climate conditions.

Q: Can I connect different-sized fans to the same controller?

A: Please refer to pages 32-34 for details on adding more fan units.

CONTROLLER 69 PRO FAQ

Q: Will I be able to use this controller with my own devices?

A: The CONTROLLER 69 PRO is only compatible with devices in the UIS ecosystem. Look for our logo on your AC Infinity device's packaging for UIS compatibility.

Q: Does the controller retain its settings after power is shut off?

A: Yes. If the controller's power is cut off and is powered on afterward, your settings will remain.

Q: My controller isn't pairing with the app. How do I fix this?

A: If the pairing process isn't successful, press any button to return to the normal screen. Then hold the port button for 5 seconds to try again. When starting the pairing process around multiple Wi-Fi controllers, move your smart device closer to the controller you wish to connect the app with.

Q: Why does the app ask me for location permissions?

A: The app requires location permissions to find the relative position of your smart controller and communicate with existing Bluetooth devices already paired with the app. All Android devices prior to system version 12.0 will require location permissions to be turned on for the Bluetooth scan to be successful.

Q: Why do the port's level digits on the screen occasionally flash when I unplug a device?

A: The controller may have received electronic interference during the disconnection. To fix this, completely cut off power from the controller by unplugging all connected devices. Then plug them back into their previous ports and resume normal use.

CLOUDLINE PRO FAQ

Q: Can I mount this inline duct fan vertically?

A: Yes. The CLOUDLINE PRO can be mounted in any orientation, including vertically.

Q: Will I be able to hardwire this fan to my own controller or thermostat?

A: We do not recommend hardwiring or splicing our fan's power wires. Such modifications may compromise electrical safety and will void this product's warranty.

Q: Do I need to use a power converter if I'm outside the US?

A: This product's voltage range is 100-240V AC. You may need a simple travel adapter to plug it into a foreign socket, or a power converter if your country uses a different voltage.

Q: What is the CFM of each of the different fan speeds?

A: Please refer to your CLOUDLINE PRO model's product listing for its CFM specification.

Q: I'm not getting enough airflow even after setting the fan speed to 10. What can I do?

A: Bends in ducting will reduce your fan's CFM performance. To retain airflow, you may straighten the ducting and eliminate as many bends as possible.

Q: Should I use this inline duct fan as an intake or an exhaust fan?

A: The CLOUDLINE PRO is primarily used as an exhaust fan, but can be used as an intake fan as well. You may use this fan as an intake fan if you need fresh air into your space.

Q: I'm hanging my fan upside down in my grow tent, can I rotate its motor box plate?

A: Yes. Use a screwdriver to unscrew the motor cap. Rotate it to your desired orientation and reapply the screws.

AC INFINITY PRODUCTS

Advance Grow Tents

The CLOUDLAB series is a line of grow tents designed to create ideal growing conditions and facilitate indoor plant cultivation year-round. Features 2000D thick oxford canvas lined with inner diamond patterned mylar that maximizes grow light luminosity, and a reinforced frame with 150 lb. weight capacity. Includes a mounting plate to install your AC Infinity controller onto.

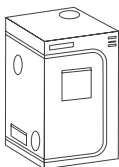

Carbon Filters

The duct carbon filter is designed to eliminate odors and chemicals for grow tents and hydroponic spaces. It utilizes premium grade Australian charcoal that features greater absorption power and a longer lifespan. Enables maximum airflow pass through as part of an intake or an exhaust system.

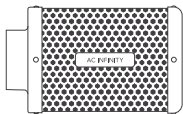

Ducting Tubes

The four-layer ducting tube is used to direct airflow, designed for ventilation systems in applications like HVAC, dryers, and grow rooms. It is highly durable and flexible, and can be used anywhere from tight spaces to wide open areas.

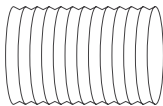

Discover the latest innovations in environmental controls at acinfinity.com

WARRANTY

This warranty program is our commitment to you, the product sold by AC Infinity will be free from defects in manufacturing for a period of two years from the date of purchase. If a product is found to have a defect in material or workmanship, we will take the appropriate actions defined in this warranty to resolve any issues.

The warranty program applies to any order, purchase, receipt, or use of any products sold by AC Infinity or our authorized dealerships. The program covers products that have become defective, malfunctioned, or expressively if the product becomes unusable. The warranty program goes into effect on the date of purchase. The program will expire two years from the date of purchase. If your product becomes defective during that period, AC Infinity will replace your product with a new one or issue you a full refund.

The warranty program does not cover abuse or misuse. This includes physical damage, submersion of the product in water, incorrect installation such as wrong voltage input, and misuse for any reason other than intended purposes. AC Infinity is not responsible for consequential loss or incidental damages of any nature caused by the product. We will not warrant damage from normal wear such as scratches and dings.

Contact our dealers department at dealers@acinfinity.com or **(626) 838-4656** for more information about our dealers and distributors program. Contact our customer service department at support@acinfinity.com or **626-923-6399** for product and warranty assistance. Our business hours are Monday through Friday, 9:00 am to 5:00 pm PST.



If you have any issues with this product, contact us and we'll happily resolve your problem or issue a full refund!

COPYRIGHT © 2022 AC INFINITY INC. ALL RIGHTS RESERVED

No part of the materials including graphics or logos available in this booklet may be copied, photocopied, reproduced, translated or reduced to any electronic medium or machine readable form, in whole or in part, without specific permission from AC Infinity Inc.

www.acinfinity.com